

INSTALLATION MANUAL



取付・取り扱い説明書

EAC002.22.12.240330.2

Thank you for purchasing this VELIT EAC002.22 Rooftop Air Conditioner. For safety and the best performance, please read and follow these instructions carefully.

Table of Contents

1. IMPORTANT SAFETY INSTRUCTION	3
1.1 Understand Signal Words	3
1.2 General Safety Message	3
2. SPECIFICATIONS	3
3. ACCESSORIES	3
4. INSTALLATION INSTRUCTIONS	3
4.1 Choosing Proper Location for the Air Conditioner	4
4.2 Attach the Sealing gasket to the Roof Opening	4
4.3 Place the Unit in the Roof Opening	4
4.4 Secure the Unit to the Mounting Brackets	4
4.5 Connect Wiring	4
4.6 Install the Decor Panel	4
5. OPERATING INSTRUCTIONS	5
5.1 Control Panel	5
5.2 Edit Low Voltage Protection	5
6. MAINTENANCE	5
6.1 Under/over voltage protection	5
6.2 Error code	5

1. IMPORTANT SAFETY INSTRUCTION

This manual has safety information to help users eliminate or mitigate the risk of accidents and injuries.

The installation of this unit MUST comply with the following code:

U.S: NFPA1192, NFPA70

CANADA: C22.1, CSA Z240

1.1 Understand Signal Words

⚠ WARNING

Indicates a hazardous situation that if NOT avoided, could result in death or serious injury.

⚠ CAUTION

Indicates a hazardous situation that if NOT avoided, could result in minor or moderate injury.

NOTICE

Indicates practices NOT related to physical injury

1.2 General Safety Message

⚠ WARNING

- This unit MUST be installed and repaired by qualified personnel who are familiar with the risk involved.
- Do NOT modify this product in any way. Any modifications can be extremely hazardous.
- Keep electrical devices out of reach of children and do not allow them to operate the device without supervision.
- Only use accessories authorized by VELIT.
- Do NOT use this unit in or near flammable environment.
- Do NOT let children use the unit without supervision

NOTICE

- Do NOT use this unit when the ambient temperature is lower than 40°F. This could cause frost inside the unit.
- Do NOT power wash the unit or use detergent to clean the unit.

2. SPECIFICATIONS

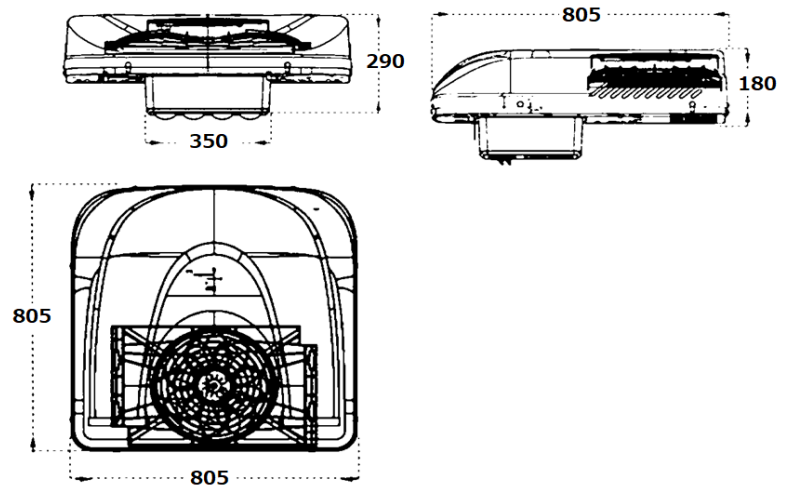

Model	R2000
電源電圧	DC 12V
動作電力	40-60A
Cooling Capacity	7000-9500Btu
Cooling Capacity	2200-2800w
Air Flow Rate	450mc/h
Rate Power	900w
冷却/冷媒 容量	R134a 750g
Power Consumption	Eco mode: 900w Boost mode: 1000w
Noise Level	Eco mode: 60dB Boost mode: 75dB
本体寸法	804(W)x290(H)x804(D)mm
Inner Unit Dimension	350(W)x108(H)x280(D)mm
Weight	30.0kg

3. INSTALLATION INSTRUCTIONS

3.1 Choosing Proper Location for the Air Conditioner

⚠ CAUTION

Make sure the roof is designed to support the weight of the unit and the weight of two installers.

⚠ WARNING

Electrical shock hazard! Make sure to disconnect all power supplies to the vehicle including battery, generator, and shore power prior to installation.

- The unit can fit over an existing 14.173in by 14.173in roof opening. For other locations, make sure the slope of the select location is less than 15 degrees and leave a clearance of at least 10" from the edge of the roof. Refer to specifications for the dimension of the unit.
- After the location has been selected, check for obstructions in the area where the unit will be installed.
- Check the inside of the camper for decor panel obstructions. Allow 6" clearance from all edges of the opening.
- Route the 6AWG power cable to the roof opening. Leave at least six inches of slack. For cables longer than 10ft, refer to NEC (National Electric Code) for proper sizing of wire (12V 60A).

4.2 Attach the Sealing gasket to the Roof Opening

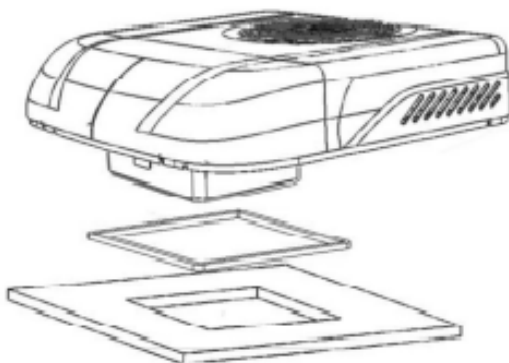

- Clean the surface between the unit and the roof where the sealing gasket will be installed.

- Apply sealant to the bottom of the sealing gasket.
- Place the sealing gasket on the roof opening.
- For better sealing, apply sealant to the edge where the sealing gasket contacts the roof.
- At the shown locations and other places if needed, stick the foam pieces between the unit and the roof to better support the unit

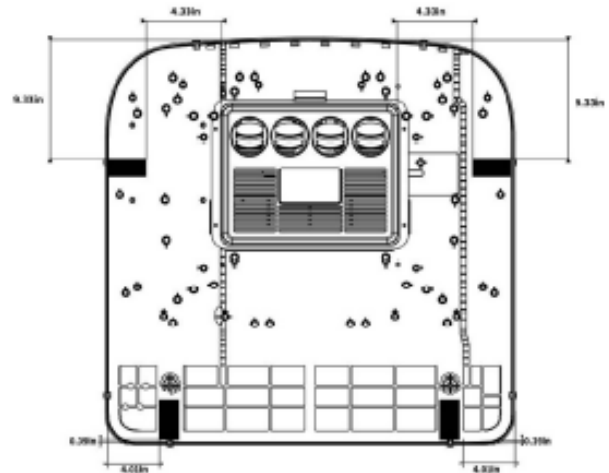

4.3 Place the Unit in the Roof Opening

- Grasp the bottom two sides of the unit, lift it, and place it into the roof opening.
- Pull out the power cable.

4.4 Secure the Unit to the Mounting Brackets

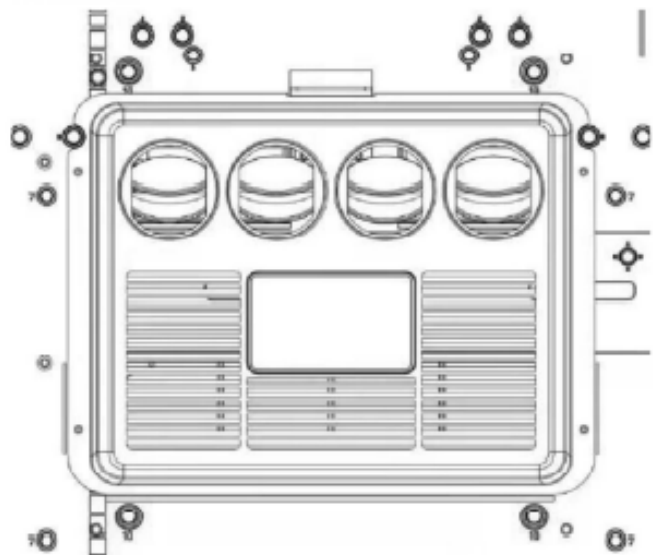

- Choose the proper length of M8 tie rods based on roof thickness.
- Insert the tie rods in the shown mounting holes (#10).

- Secure the tie rods with nuts.
- Use the M8 tie rods as guidance, place the mounting brackets, and secure the brackets with provided washers and nuts. Cut the bolt to desired length if needed.

NOTICE DO NOT OVERTIGHTEN!

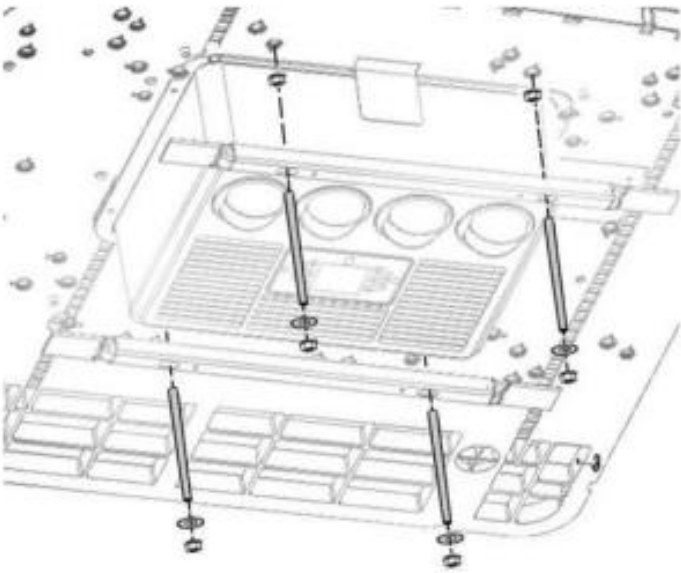

4.5 Connect Wiring

- Connect the unit to the power cable. On this end, the cable should have fuse boxes on both positive and ground.
- On the other end of the power cable, connect to the battery. On this end, there is only one fuse box on positive.

4.6 Install the Decor Panel

- Use the provided self-tightening screws and washers to secure the decor panel to the roof.

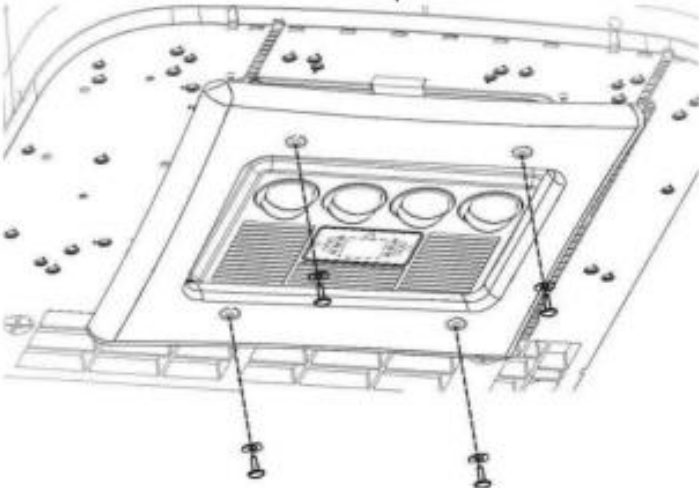

4. OPERATING INSTRUCTIONS

5.1 本体パネル・操作

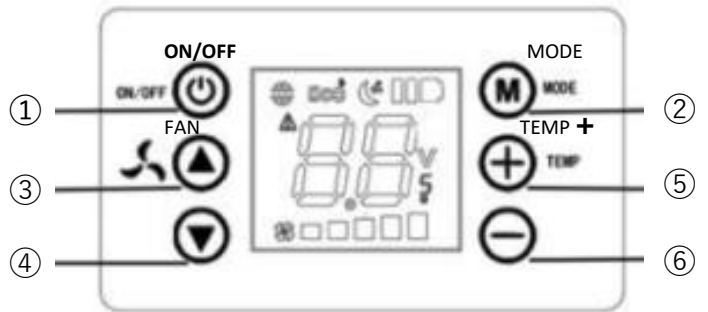

- 1-電源ボタン：
ON ボタンタッチ
OFFボタンタッチ

* 10秒以上押し続けると初期設定状態になります

- 2-モード切替：送風・急速・省エネ・スリープ
3-風量切替：▲ 風量を上げる
4-風量切替：▼ 風量を下げる
5-温度設定：+ 温度を上げる
6-温度設定：- 温度を下げる

5.2 Edit Low Voltage Protection

Long press the Mode Switch to edit low voltage protection. Press Fan Speed + to increase cut-off voltage. Press Fan Speed - to decrease cut-off voltage. Press Temperature + to increase recover voltage. Press Temperature - to decrease recover voltage.

5. MAINTENANCE

6.1 Under/over-voltage protection

Low voltage protection will auto shut off the unit when the supplied voltage is lower than the cut-off voltage (default 10.5V) and the low-voltage red light will light up. The unit will turn on automatically once the supplied voltage is higher than the recover voltage (default 12V).

When the supplied voltage is higher than 18V, the unit will turn off and the high-voltage red light will light up. The unit will turn on automatically once the supplied voltage is lower than 18V.

リモコンの操作 / ディスプレイの説明

クーラー-AUTOモード表示

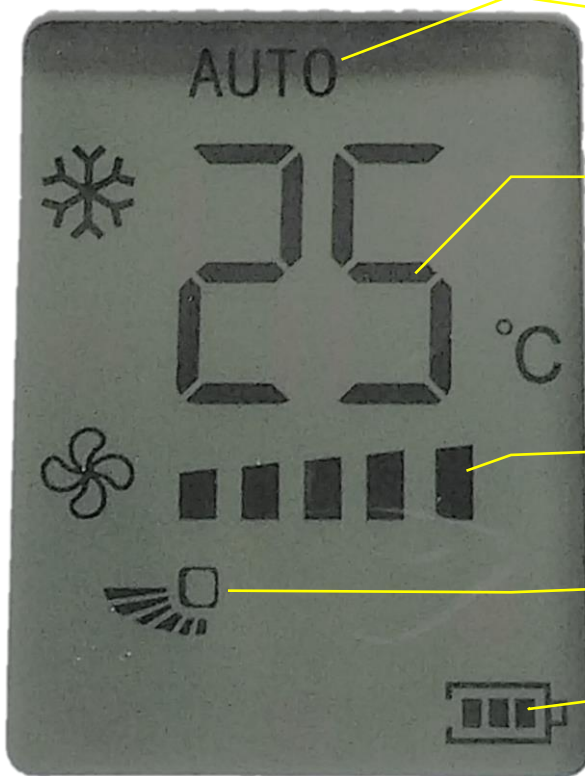

モード：ECO / AUTO / TURBO

温度表示（設定温度）

風量：5段階 / 1.2.3.4.5.6(AUTO)

* 風向 / 本製品では使用しません

リモコン電池残量

ECOモード

AUTOモード

TURBOモード

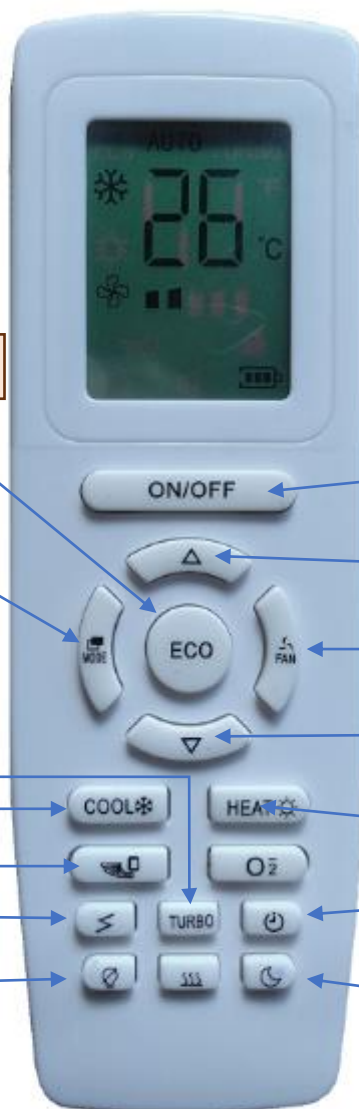

モード選択

1：ECOモード

* モード選択の方法
リモコンのコマンドキーでも選
択できます。

- 1：ECOモード
- 2：AUTOモード
- 3：TURBOモード
- 4：ナイトモード

電源スイッチ

温度上げる +

風量調節 5段階
6段階でAUTOモード

温度下げる -

3：TURBOモード

クーラーモード

電圧表示

LEDライトS/W

オフタイマー設定
1時間から8時間迄

ナイトモード

6.2 Error code

There are multiple sensors built inside the unit. When an error is detected, the error icon will flash with the error code displayed. Check the table below for the meaning of the error codes and contact customer service when needed.

E0	Faulty ambient temperature sensor
E1	Faulty evaporator temperature sensor error
E2	Over-current protection
E3	Blocked rotor protection
E4	Low-voltage protection
E5	Short protection/faulty controller
E6	Over-voltage protection
E8	Faulty evaporator fan
EF	Condenser fan short/over-current/faulty
Eb	Controller lack-phase protection
EU	Controller overheated

株式会社RV東陽

〒 350-0411
埼玉県入間郡越生町大字黒岩299番地1
電話番号：049-298-7556
FAX：049-298-7506
e-mail：rv-toyo@rv-toyo.jp
URL：rv-toyo.jp

■ 英文の直訳のため、記載内容が原文と異なる場合がありますご了承ください。

■ 製品の仕様 付属品の内容など予告なく変更する場合があります。